



PROTEUS

Protein A Antibody Purification Handbook

Mini & Midi spin columns

SECTION 1

Introduction	2
Proteus benefits	3
Contents of a Proteus spin column kit	4
Additional equipment recommended	8
Storage conditions	8
Technical support	9
Specifications	10

SECTION 2

Principles of Protein A and G chromatography	11
Affinity chromatography	12
General conditions for optimal binding	16
Choosing the correct buffer conditions	18
Eluting the protein from a Proteus spin column	18
Binding kinetics of Proteus A spin columns	20
Protein A affinity resin	22
Choosing between Protein A and G	24

SECTION 3

Easy-to-read protocols for purifying antibodies using Protein A	25
Delipidation procedure	26
Buffers in the kit	26
Step by step Mini protocol	27
Step by step Midi protocol	31

APPENDIX

Procedure to convert RPM to RCF in a swing bucket rotor	37
Procedure to convert RPM to RCF in a fixed angle rotor	38
Protein A kit buffer formulation	39
Questions and answers	40
Troubleshooting assistant	46
Glossary	47
References	49
Ordering information	50



Introduction:

Affinity purification of monoclonal antibodies has been largely confined to the use of Protein A and Protein G chromatography. The Proteus A kit is designed for simple, rapid antibody purification from serum, ascites and tissue culture supernatant such as those derived from static cultures and bioreactors. Proteus spin columns replace lengthy and expensive chromatographic methods such as FPLC®.

This Proteus antibody purification kit incorporates pre-packed Protein A resin plugs in ready-to-use spin columns. The objective is to offer the researcher total protein purification solutions from the initial fractionation stage to the final polishing steps. Resolution of the monoclonal antibody is achieved either in a 2.2 ml microcentrifuge tube for the Proteus Mini spin column or in a 50 ml centrifuge tube for the Proteus Midi spin column.

The rapid purification protocols provided in this handbook for affinity chromatography permit the recovery of high levels of pure antibodies in minutes. Large numbers of samples can be processed at the same time. There is negligible hold-up volume; ensuring high solute recovery with minimal non-specific absorptive losses. Proteus employs powerful resin-based technology for separating proteins and involves only a few steps, making the isolation of pure antibody samples rapid and simple to perform. Antibody samples purified using Proteus spin columns may be used in a wide range of laboratory procedures such as 1D or 2D polyacrylamide gel electrophoresis, Western blotting, ELISA, immunohistochemical or immunofluorescence studies. The antibodies are sufficiently pure for radiolabelling, conjugations (for example fluorescein) or preparation of immuno-affinity columns.

FPLC® is a registered trademark of Amersham Biosciences

Proteus Benefits:

- Proteus A kits are designed to eliminate tedious chromatographic steps normally associated with Protein A chromatography.
- Proteus A reduces time-to-purity by incorporating protocols to suit various applications, supported by a comprehensive handbook and required buffers in a convenient kit format.
- The beaded supports offer excellent flow properties. This combined with the tapering of the spin column provides uniform flow paths that allow optimal use of the available resin bed in swing bucket rotors.
- Negligible hold-up volume of the Protein A resin plug ensures high antibody recovery.

- The provision of a disposable spin column is ideally suited to GMP production where current user requirements and price sensitivities demand regeneration of the affinity matrix using harsh treatments e.g. peroxyacetic acid for Protein A or G resins.

Proteus Mini Spin Column



Proteus Protein A Mini Plug

Proteus Midi Spin Column

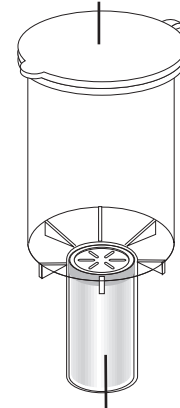

Proteus Protein A Midi Plug

Proteus Protein A Mini spin column kit contents:

The Proteus Mini kit contains:

- 16 x Proteus spin column plugs containing Protein A-agarose resin.
- 16 x Proteus spin column barrels (0.65 ml capacity in a fixed angle rotor).
- 32 x 2.2 ml microcentrifuge tubes.
- 16 x 10 kDa MWCO (Polyethersulphone) ultrafiltration spinners.
- 1 x 250 ml 1 x binding buffer (buffer A) bottle.
- 1 x 125 ml 1 x elution buffer (buffer B1) bottle.
- 1 x 125 ml 1 x elution buffer (buffer B2) bottle.
- 1 x 30 ml neutralization buffer (buffer C) bottle.
- Plug insertion tool.
- Comprehensive handbook.
- Ultrafiltration spinner instruction sheet.
- Laminated protocol card.

Proteus Protein A Mini spin column kit contents:

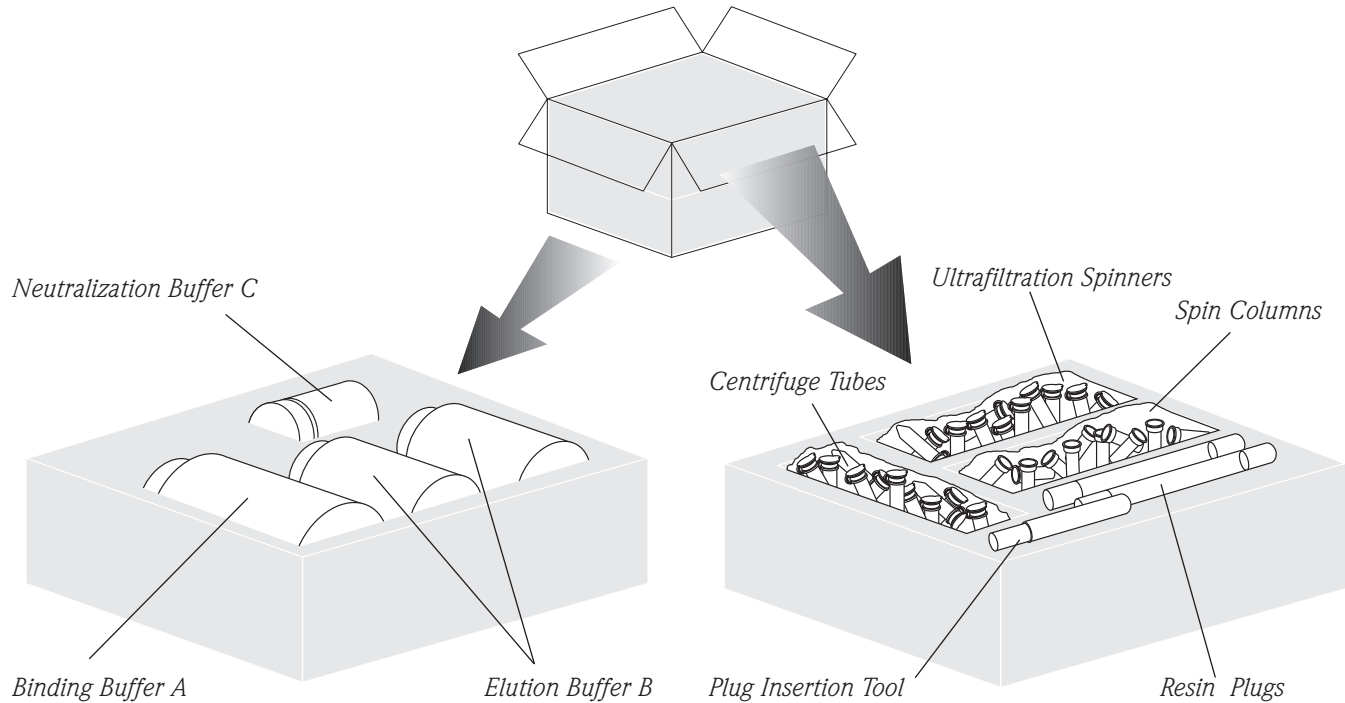

Proteus Protein A Midi spin column kit contents:

The Proteus Midi kit contains:

- 4 x Proteus spin column plugs containing Protein A-agarose resin.
- 4 x Proteus spin column devices (20 ml capacity in a swing bucket rotor).
- 8 x 50 ml centrifuge tubes.
- 4 x 10 kDa MWCO (Regenerated cellulose) ultrafiltration spinners.
- 1 x 250 ml 1 x binding buffer (buffer A) bottle.
- 1 x 125 ml 1 x elution buffer (buffer B1) bottle.
- 1 x 125 ml 1 x elution buffer (buffer B2) bottle.
- 1 x 30 ml neutralization buffer (buffer C) bottle.
- Plug insertion tool.
- Comprehensive handbook.
- Ultrafiltration spinner instruction sheet.
- Laminated protocol card.

Proteus Protein A Midi spin column kit contents:

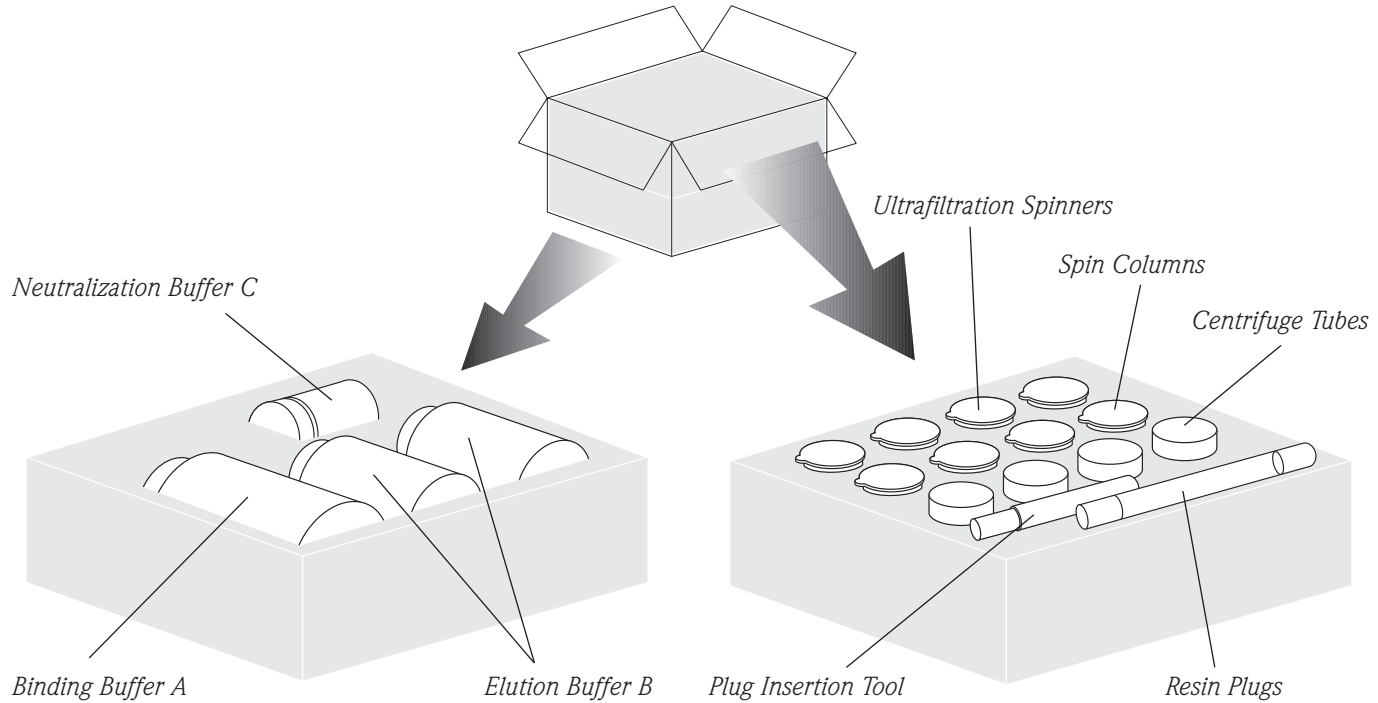

Additional equipment recommended:

- Filters units: 0.2 and 1.2 μm syringe filters for clarification. Our recommended filter unit is the 0.2 μm Steriflip® GP unit from Millipore Corp (Cat. No: SCGP 005 25).
- Quartz cuvettes for UV absorbance measurements.
- UV/VIS spectrophotometer.
- Pasteur pipettes and micro-pipettes.
- Marker pen and test tube rack.
- A bench-top centrifuge with swing bucket rotor that can accommodate 50 ml centrifuge tubes.
- A microcentrifuge that can accommodate 2.2 ml microcentrifuge tubes.

*N.B. (For the Midi spin column only). The preferred rotor is a **swing bucket** rotor. For optimal performance with a fixed angle rotor, ensure that the orientation of the spin column in the rotor is the same for sample binding, washing and elution steps.*

Storage conditions:

Remove the Proteus Protein A plug box from the kit and store it at 2-8 °C. There is no need to place the rest of the kit in a fridge or cold room. All buffers, for example, contain 0.1 % sodium azide and can be stored at room temperature. Do not freeze the resin plugs or store them at room temperature. Freezing the suspension will damage the agarose beads. The resin is pre-swollen and de-fined. It is transported in 0.01 % Thimerosal. Proteus spin columns are stable for up to 2 years at 2-8 °C from the date of manufacture. Expiry date is recorded clearly on the outside of the pack.

Disclaimer:

This product is for research use only and is not intended for use in clinical diagnosis. No claims beyond replacement of unacceptable material or refund of purchase price shall be allowed.



Technical support:

Contact the Prochem technical support and sales center for assistance:

In USA & Canada toll free

Tel: 866 635 3738

Tel: 978 952 6285

Fax: 978 952 6143

E-mail: info@protein-chem.com

Web: www.protein-chem.com

Mail: Pro-Chem Inc.
521 Great Road
Littleton, MA 01460,
USA.

Specifications:

Source:	Recombinant Protein A expressed in <i>E. coli</i> (N.B. No toxic bacterial contaminants normally found in native Protein A)	Typical binding capacity:	≥ 20 mg rabbit IgG (Midi) ≥ 1 mg rabbit IgG (Mini) (Note that the Protein A resin can have different binding capacities to subtypes of immunoglobulins derived from the same species).
Supporting Proteus matrix:	Covalently coupled to agarose resin	Leaching levels:	< 5 ng recombinant Protein A/ml (as measured by ELISA)
Max sample volume:	20 ml (Midi, Swing bucket rotor) 0.65 ml (Mini, Fixed angle rotor)	Chemical stability:	High
Resin bed volume:	1.6 ml (Midi) 0.23 ml (Mini)	Endotoxin levels:	Unknown
Ligand density:	3.5 mg Protein A/ml resin	Toxin levels:	Free of <i>Staphylococcus</i> enterotoxins and hemolysins
Bead size range:	60-165 μm	Solubility in water:	Insoluble
Recommended working pH:	pH 2.5-9.0	Colour coded end-caps:	Red



Chemical compatibility of the Proteus spin columns:

All resins are susceptible to oxidative agents. Avoid high temperatures. The spin columns have high chemical resistance to short exposure to organic solvents (e.g. 70 % ethanol, 5.8 M acetic acid) and are stable in all aqueous buffers commonly used for Protein A chromatography. Protein A is resistant to 6 M guanidine-HCl, 8 M urea and 2 M sodium isothiocyanate.

Immuno-affinity separations:

Three types of immunoaffinity ligands are commonly employed:

- (i) Protein A & G.
- (ii) Antibody directed against the monoclonal species (usually anti-mouse IgG).
- (iii) Antigen to which the monoclonal antibody was raised.

Principles of Protein A and G chromatography:

This handbook focuses specifically on Protein A affinity chromatography. All modes of chromatography can be used effectively for the separation of antibodies. Although ion exchange chromatography can resolve different polyclonal antibodies and different subclasses, a degree of customization of the protocol is required. Affinity techniques include Protein A or G, immobilized anti-antibodies and immobilized antigens. The simplicity of Protein A is extremely attractive as it lends itself to the bind, wash and elute mode of operation if the appropriate buffer formulations are selected. The use of Protein A and G is widespread and has largely superseded the use of anti-antibodies. Protein A chromatography therefore, remains the principal theme of this handbook.

Application drivers for Protein A and G chromatography:

Monoclonal antibody purification for solution state assays and Western blotting	Mini & Midi
Semi-preparative antibody purification	Midi
Purification of polyclonal antibodies for solution state assays and Western blotting	Mini & Midi
Removal of endotoxins from an antibody solution	Mini & Midi
Small scale antibody purification	Mini
Screening antibody expression	Mini
Immunoprecipitation studies	Mini
Purification of antibodies for immunohistochemical and immunofluorescence studies	Mini

Affinity chromatography:

The essence of affinity chromatography utilizes the concept of bio-specificity, implying an interaction between a natural binding site and the natural ligand, whether it be enzyme-substrate, enzyme-inhibitor or Protein A/G-antibody interactions.

Often a researcher needs to choose the correct base matrix, select the optimal activation chemistry and couple a suitable ligand to develop an affinity column to purify the target protein. Proteus spin columns remove the guesswork associated with optimizing the resin chemistry by offering ready-to-use resin plugs that have satisfied stringent quality control to guarantee reproducible purification performance. Many affinity support preparations require less than 5 ml resin so these Mini and Midi spin columns contain ideal bed volumes.

The only decisions required by the researcher are whether they wish to work with Protein A or G resin. Optimal buffer and elution conditions for the purification step of many common IgG subclasses have been defined and these are supplied with the kits.

Most polymeric mini-columns currently offered operate by gravity flow and typically contain less than 5 ml resin. The columns are normally constructed from polystyrene or polypropylene with a simple barrel and the addition of porous disks to contain the resin. However, the affinity separation often takes several hours to complete; in addition the researcher usually has to pack the column, which can add a minimum 2 further hours to the purification step. The elaborate nature of the packing means that it is usually undertaken by an experienced laboratory worker.

The majority of purifications require fast processing times to minimise the hydrolytic actions of proteases. Proteus Protein A kits allow multiple parallel purifications to be achieved without the need to employ expensive PEEK tubing (protein-friendly)-based chromatography systems. For example, 12 parallel small scale antibody purifications can be achieved in a microfuge containing a 12 tube fixed angle rotor.

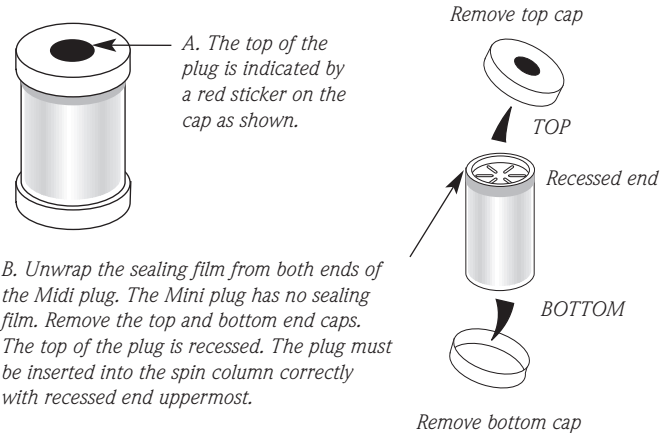
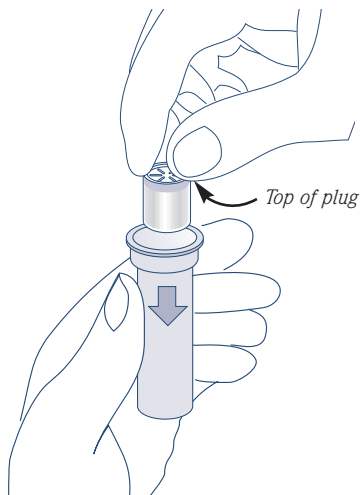

Fig. 1. Schematic diagram of a Proteus Mini or Midi spin column plug.

The plug and play concept for the Proteus Mini spin column

Loading the plug into the spin column



Place the plug into the spin column with the recessed end uppermost.

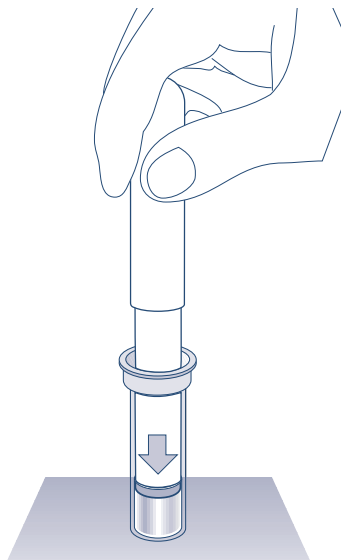

*Push the plug **FULLY** into the tapered end of the spin column using the plug insertion tool.*

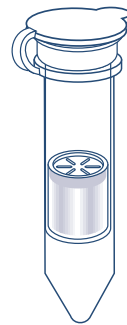

It is now ready for pre-equilibration with binding buffer followed by centrifugation.

The plug and play concept for the Proteus Midi spin column

Loading the plug into the spin column

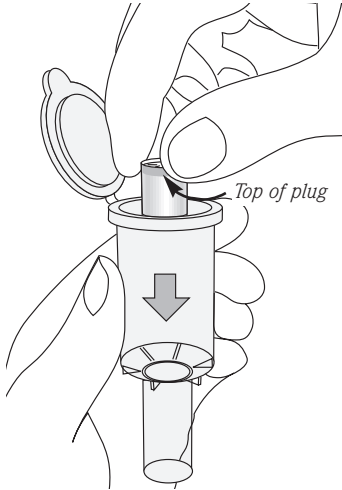

Place the plug into the spin column with the recessed end uppermost.

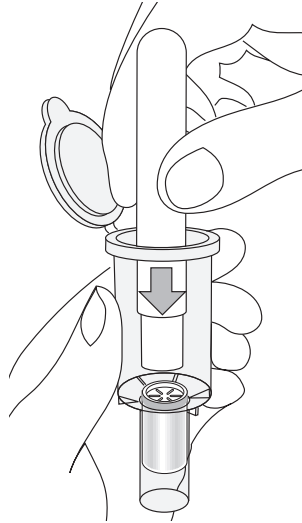

*Push the plug **FULLY** into the tapered end of the spin column using the plug insertion tool.*

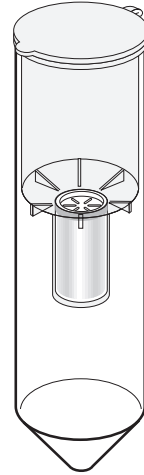

It is now ready for pre-equilibration with binding buffer followed by centrifugation.

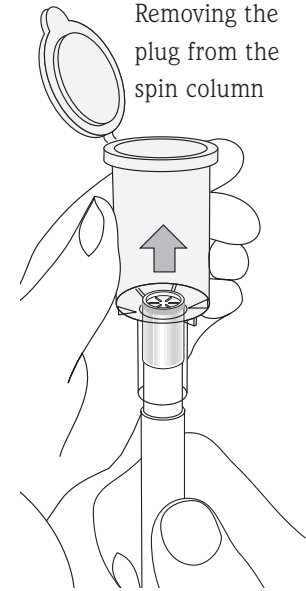

Removing the plug from the spin column

After use, the plug is removed using the plug insertion tool.

General considerations for selecting optimal binding conditions for Proteus Protein A spin columns.

Any sample, such as a crude biological extract, a cell culture supernatant, serum, ascites or an artificial standard can be used in the Proteus A spin column. It is important that the sample is first filtered through a **0.2 μm** filter to remove particulates that could clog the resin flow channels. All samples should be filtered just prior to loading even if they have been filtered several days before the chromatographic run. Aggregation/precipitation of proteins is common during storage and repeated freeze/thaw cycles in sera, ascites and tissue culture supernatants. Lipids, which can be found at high levels in serum or ascites should also be removed (see delipidation protocol on page 26). Of equal importance is the ability to process the samples rapidly and, if the need arises, to be able to purify the target protein in a Proteus spin column at 4 °C.

Optimal conditions for binding the target molecule to a resin are critical for successful separation of the protein. If the binding conditions are not optimal with respect to pH, salt concentration, presence or absence of metal ions etc, the interaction could be weak or non-existent. In many instances, the sample needs to be dialysed or diafiltered by ultrafiltration before it is applied to an affinity or ion exchange chromatographic support. In Protein A or G separations, the sample should simply be diluted 1:1 (v/v) in 1 x binding buffer provided in the kit.



The interaction of immobilized Protein A or Protein G with immunoglobulins (Igs) is pH-dependent. The binding capacity for Protein A is optimal at pH 8-9, whereas the binding capacity of Protein G is high over a broader pH range. Salt concentration can significantly affect the binding of mouse Igs to Protein A by reducing severe ionic interactions and enhancing hydrophobic interactions. Mouse IgG1, rat IgG1 and rat IgG2b bind well to immobilized Protein A when the salt concentration is higher than 1 M, but bind poorly at low salt concentrations. Note, however, that their binding capacities can be substantially lower than those antibodies that bind strongly to Protein A or G resin.

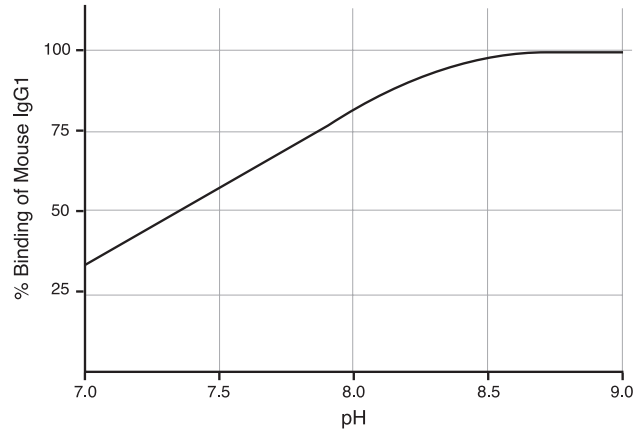

Fig. 2. Typical pH dependence of binding of mouse IgG1 to Protein A.

Choosing the correct buffer conditions for Protein A separations:

Typical binding buffers employed in Protein A affinity separations are:

- (i) 1-1.5 M Glycine/NaOH, 2-3 M NaCl pH 9.0
- (ii) 1 M Sodium borate, 2 M NaCl pH 9.0
- (iii) 0.1 M Sodium phosphate, 0.1 M NaCl pH 7.4 (PBS)

Typical elution buffers employed in Protein A affinity separations are:

- (i) 0.1 M Sodium citrate pH 3.0-6.0
- (ii) 0.1-0.2 M Glycine/HCl pH 2.5-3.0
- (iii) 0.1 M Sodium phosphate pH 3.0-6.0

The typical neutralization buffer used for Protein A affinity separations is:

- (i) 1 M Tris/HCl pH 9.0

Eluting the antibody from a Proteus A spin column:

The most common elution conditions for Protein A or G affinity and immuno-affinity separations involve a reduction in pH to between pH 2.5 and 5.0 (See Table 1, page 19). It is important to appreciate that a few proteins (e.g. some monoclonal antibodies) are acid-labile and they can lose their activity at very low pH values. Above all, the elution conditions must preserve the integrity and activity of the target protein. Most observed denaturation is caused by harsh elution conditions. Acidic pH is known to reduce the antibody titre, decrease immuno-reactivity and distort the antibody structure. It is therefore critical that the pH is restored to neutrality after elution.

Table 1. Affinity of Protein A for IgG subclasses.

Species	Subclass	Binding pH	Elution pH
Mouse	IgG1	8.5-9.0	6.0-7.0
Mouse	IgG2a	8.0-9.0	4.5-5.5
Mouse	IgG2b	8.0-9.0	3.5-4.5
Mouse	IgG3	8.0-9.0	4.0-7.5
Rat	IgG1	8.0-9.0	6.0-8.0
Rat	IgG2a	9.0	7.5-9.0
Rat	IgG2b	8.0-9.0	7.0-8.0
Rat	IgG2c	8.0-9.0	3.0-7.0
Human	IgG1	7.0-7.5*	2.5-4.5
Human	IgG2	7.0-7.5*	2.5-4.5
Human	IgG3	7.0-7.5*	3.0-7.0
Human	IgG4	7.0-7.5*	2.5-4.5
Rabbit	IgG	7.5	3.0-7.0
Guinea pig	IgG1	7.5-9.0	4.0-5.0
Guinea pig	IgG2	7.5-8.0	3.0-4.5

*Experiments in our laboratory show that human IgG binds well to Proteus Protein A spin columns at pH 9.0 (the pH of the binding buffer supplied in the Proteus Protein A kit). However, Proteus Protein G spin columns may be more suited to the purification of IgG from human serum.

Binding kinetics of Proteus A spin columns

The flow rate through an affinity chromatography support is important in achieving optimal separation. Flow rate through the column support is inextricably related to the efficiency of the separation; too fast a flow will cause the mobile phase to move past the beads faster than the diffusion time necessary to reach the internal bead volume. Our studies demonstrate that the large internal surface area of the Proteus Midi resin bed compensates completely for the velocity of the mobile phase through the column support when the centrifugal speed does not exceed 1,500 g*.

Centrifugal speeds as high as 13,000 rpm (equivalent to 11,960 g in a fixed rotor with an average radius of 49 mm) have been achieved with the Proteus Protein A and G Mini spin columns. The Protein A resin chemistries used in the Proteus spin column have sufficiently rapid association kinetics between the protein molecule and the immobilized ligand to allow for optimal diffusional flow through the internal bead structure. Traditionally, gravity flow chromatography is very slow and resolution of the protein separation can be adversely affected by secondary diffusion effects.

* No Proteus Midi Protein A and G performance data is available for centrifugal speeds greater than 1,500 g.



Source	Type	Total Ab	Specific Ab	Contamination
Serum	Polyclonal	10 mg/ml	1 mg/ml	Other serum Ab
Static Culture	Monoclonal	1 mg/ml	0.05 mg/ml	Medium serum Ab
Bioreactor	Monoclonal	10 mg/ml	9 mg/ml	Medium serum Ab
Ascites	Monoclonal	10 mg/ml	9 mg/ml	Mouse Ab

Protein A affinity resin:

Protein A is a cell wall protein from *Staphylococcus aureus* with a molecular weight between 35-50 kDa.

The quality of the Protein A agarose is important to avoid leakage of Protein A during the elution procedure.

Immobilized Protein A resins linked via an amide bond between the amino groups of Protein A or G and either oxirane or N-hydroxysuccinimide ester groups form the most stable cross-links. Immobilized Protein A binds specifically to the Fc region of immunoglobulin molecules of many mammalian species.

Protein A affinity chromatography is a rapid one-step purification, which removes most non-IgG contaminants and can achieve purities close to homogeneity. It is particularly useful for purifications of tissue culture supernatant, where 10-100 fold concentrations can be achieved.

Key code for relative affinity of Protein A & G for respective antibodies:

✓✓✓✓	=	Strong affinity
✓✓✓	=	Moderate affinity
✓✓	=	Weak affinity
✓	=	Slight affinity
✗	=	No affinity



Binding Affinities of Protein A and Protein G

	Protein A	Protein G		Protein A	Protein G
Human IgG1	✓✓✓✓	✓✓✓✓	Rabbit IgG	✓✓✓✓	✓✓✓
Human IgG2	✓✓✓✓	✓✓✓✓	Hamster IgG	✓	✓✓
Human IgG3	✗	✓✓✓✓	Guinea Pig IgG	✓✓✓✓	✓✓
Human IgG4	✓✓✓✓	✓✓✓✓	Bovine IgG	✓✓	✓✓✓✓
Human IgA	✓✓	✗	Sheep IgG	✓/✗	✓✓
Human IgD	✓✓	✗	Goat IgG	✓/✗	✓✓
Human IgE	✓✓	✗	Pig IgG	✓✓✓	✓✓✓
Human IgM	✓✓	✗	Chicken IgG	✗	✓
Mouse IgG1	✓	✓✓			
Mouse IgG2a	✓✓✓✓	✓✓✓✓	<i>Fragments</i>		
Mouse IgG2b	✓✓✓	✓✓✓	Human Fab	✓	✓
Mouse IgG3	✓✓	✓✓✓	Human F(ab') ₂	✓	✓
Mouse IgM	✓/✗	✗	Human scFv	✓	✗
Rat IgG1	✗	✓	Human Fc	✓✓	✓✓
Rat IgG2a	✗	✓✓✓✓	Human κ	✗	✗
Rat IgG2b	✗	✓✓	Human λ	✗	✗
Rat IgG2c	✓	✓✓			
Rat IgM	✓/✗	✗			

Choosing between Protein A and Protein G

Proteus spin columns:

Immunoglobulin G from most species consists of several subclasses with different biological properties. Four subclasses of IgG have been identified in human (IgG1, IgG2, IgG3, and IgG4) and in mouse (IgG1, IgG2a, IgG2b and IgG3). For immunological studies, it is often necessary to isolate one particular subclass of IgG from the other subclasses.

Protein G binds to all major Ig classes except IgM and therefore has a wider reactivity profile than Protein A. However, the binding of Igs to Protein G is often stronger, making elution and complete recovery of the immunoglobulin more difficult. Interestingly, due to the lower cost of Protein A compared to Protein G, researchers tend to experiment first with Protein A followed by Protein G. Protein A withstands harsher conditions used in cleaning-in-place procedures. However, Proteus spin columns obviate the need for cleaning.

The affinity of interaction of Protein A with mouse IgG subclasses varies. The most common subclass of mouse monoclonal antibodies is IgG1. Customization of the purification strategy may be required for the affinity separation as mouse IgG1 does not generally bind well to protein A. However, as the affinity interaction is pH- and salt-dependent, under high salt regimes (2-3 M NaCl) and high pH (pH 8-9), the antibodies will bind to Protein A.

The needs of the researcher dictate that the speed of sample processing, the cost and the reproducibility are key criteria for selecting purification tools. By selecting immunoglobulin-binding proteins with the appropriate cross-reactivities coupled to careful design of the strategic protocol, objectives such as the selective recovery of therapeutic antibodies from complex mixtures is assured.



Table 2. Physical properties of immunoglobulin subclasses.

Immunoglobulin	IgG1	IgG2	IgG3	IgG4	IgM	IgA1	IgA2	sIgA	IgD	IgE
Heavy chain	γ_1	γ_2	γ_3	γ_4	μ	γ_1	α_1	α_1 or α_2	δ_1	ϵ_1
Mean serum concentration (mg/ml)	9	3	1	0.5	1.5	3.0	0.5	0.05	0.03	0.00005
Sedimentation constant	7S	7S	7S	7S	19S	7S	7S	11S	7S	8S
Molecular weight	146,000	146,000	170,000	146,000	970,000	160,000	160,000	385,000	184,000	188,000
Molecular weight of heavy chain	51,000	51,000	60,000	51,000	65,000	56,000	52,000	52-56,000	69,700	72,500
Number of heavy chain domains	4	4	4	4	5	4	4	4	4	5
% Carbohydrate	2-3	2-3	2-3	2-3	12	7-11	7-11	7-11	9-14	12

Protocol for purifying monoclonal antibodies using Proteus Protein A kits

Immunoglobulin binding proteins have been used extensively for the purification of IgG molecules from serum, ascites, or cell culture supernatants such as those derived from static cultures and bioreactors. The affinity of Protein A for the Fc region of immunoglobulins makes it the natural ligand choice for many researchers involved in IgG isolation. We recommend the following elution buffers in Table 3 (page 27 (Mini) and 31 (Midi)) with the respective subclass of antibodies.

Delipidation procedure:

All protein A & G affinity columns are affected by the presence of lipids and lipoproteins, especially in antibody samples derived from ascites fluid. For end users who have antibody solutions which they need to delipidate, the following protocol is a gentle and easy method for removing lipids and lipoproteins.

- 1) Add 0.04 ml 10% dextran sulphate solution and 1 ml 1 M calcium chloride per ml sample.
- 2) Mix for 15 min.
- 3) Centrifuge at 10,000 g for 10 min.
- 4) Discard the precipitate.
- 5) Exchange the sample into TBS (Tris Buffered Saline) using dialysis, ultrafiltration or a desalting column. Do not buffer exchange into a phosphate-containing buffer such as PBS.

Buffers in the kit:

All buffers contain 0.1% sodium azide as a preservative.

- Binding buffer (Buffer A):
1.5 M Glycine/NaOH buffer, 3 M NaCl, pH 9.0
- Elution buffer (Buffer B1):
0.1 M Sodium citrate buffer pH 5.5
- Elution buffer (Buffer B2):
0.2 M Glycine/HCl buffer pH 2.5
- Neutralization buffer (Buffer C):
1 M Tris/HCl buffer pH 9.0



Table 3A. Mini spin columns:

Choice of Binding, Elution and Neutralization Buffers for the following antibody subclasses and host species.

Species	Subclass	Binding buffer	Elution buffer	Neutralization buffer (NB)
Mouse	IgG1	Buffer A	Buffer B1 →	Buffer C (add 25 μ l NB to 0.5 ml final eluate) followed by →
			Buffer B2 →	Buffer C (add 65 μ l NB to 0.5 ml final eluate)
Mouse	IgG2a	Buffer A	Buffer B2 →	Buffer C (add 65 μ l NB to 0.5 ml final eluate)
Mouse	IgG2b	Buffer A	Buffer B2 →	Buffer C (add 65 μ l NB to 0.5ml final eluate)
Mouse	IgG3	Buffer A	Buffer B2 →	Buffer C (add 65 μ l NB to 0.5 ml final eluate)
Rat	IgG1	Buffer A	Buffer B1 →	Buffer C (add 25 μ l NB to 0.5 ml final eluate) followed by →
			Buffer B2 →	Buffer C (add 65 μ l NB to 0.5 ml final eluate)
Rat	IgG2a	Buffer A	Buffer B1 →	Buffer C (add 25 μ l NB to 0.5 ml final eluate) followed by →
			Buffer B2 →	Buffer C (add 65 μ l NB to 0.5 ml final eluate)
Rat	IgG2b	Buffer A	Buffer B1 →	Buffer C (add 25 μ l NB to 0.5 ml final eluate) followed by →
			Buffer B2 →	Buffer C (add 65 μ l NB to 0.5 ml final eluate)
Rat	IgG2c	Buffer A	Buffer B2 →	Buffer C (add 65 μ l NB to 0.5 ml final eluate)
Human	IgG1	Buffer A	Buffer B2 →	Buffer C (add 65 μ l NB to 0.5 ml final eluate)
Human	IgG2	Buffer A	Buffer B2 →	Buffer C (add 65 μ l NB to 0.5 ml final eluate)
Human	IgG3	Buffer A	Buffer B2 →	Buffer C (add 65 μ l NB to 0.5 ml final eluate)
Human	IgG4	Buffer A	Buffer B2 →	Buffer C (add 65 μ l NB to 0.5 ml final eluate)
Rabbit	IgG	Buffer A	Buffer B2 →	Buffer C (add 65 μ l NB to 0.5 ml final eluate)
Guinea pig	IgG1	Buffer A	Buffer B2 →	Buffer C (add 65 μ l NB to 0.5 ml final eluate)
Guinea pig	IgG2	Buffer A	Buffer B2 →	Buffer C (add 65 μ l NB to 0.5 ml final eluate)

For all other Igs e.g. Hamster IgG, use elution buffer B2 only.

Step by step protocol for Mini Spin Columns

RESIN PLUG LOADING

1. Load the pre-packed resin Mini plug containing immobilized recombinant Protein A resin into the barrel of the Proteus spin column using the insertion tool as shown on page 14.

PRE-EQUILIBRATION (Total spin time = 2 mins)

2. Equilibrate the Protein A spin column with 0.65 ml binding buffer A, pH 9.0 by centrifuging the spin column at 1,800 g (4,400 rpm in a Heraeus Biofuge Pico or 5,000 rpm in a Sanyo MSE Micro Centaur) for 1 min*. Repeat this pre-equilibration step with 0.65 ml binding buffer A, pH 9.0 at 1,800 g for 1 min.

CLARIFICATION OF SAMPLE

3. Filter 1 ml sample through a single 0.2 μm syringe filter to remove any cellular debris.

N.B: Protein precipitation is common during storage and repeated freeze/thaw cycles in ascites, sera and tissue culture supernatants. As with all forms of chromatography, it is important that the sample is filtered through a final 0.2 μm syringe filter **immediately** before loading it on to the spin column.

* If 1 spin column is to be used, ensure that the spin column is counterbalanced in the microfuge with a microcentrifuge tube filled with the correct level of water.

SAMPLE LOADING (Total spin time = 6 mins)

4. Dilute the sample 1:1 (v/v; eg. add 0.5 ml 0.2 μm filtered sample to 0.5 ml binding buffer A, pH 9.0). Mix by inverting the capped tube 3-4 times. Pipette the 0.65 ml sample into the spin column. Centrifuge the spin column at 640 g (2,600 rpm in a Heraeus Biofuge Pico or 3,000 rpm in a Sanyo MSE Micro Centaur) for 6 min.

N.B: Increase the spin time or speed if any sample remains above the plug.

WASHING (Total spin time = 6 mins)

5. Wash the spin column three times with 0.65 ml binding buffer A, pH 9.0 to remove unbound contaminants by centrifuging the Proteus spin columns for 2 min at 1,800 g (4,400 rpm in a Heraeus Biofuge Pico or 5,000 rpm in a Sanyo MSE Micro Centaur). The unbound wash will contain non-immunoglobulin components.

ELUTION (Total spin time = 4 mins)

For purifying mouse IgG1, rat IgG1, rat IgG2a, rat IgG2b and bovine IgG1, use both elution steps 6 and 7.

ELUTION (Total spin time = 4 mins)

For purifying unassigned IgG, mouse IgG2a, mouse IgG2b, mouse IgG3, rat IgG2c, human IgG1-IgG4, rabbit IgG, guinea pig IgG1, guinea pig IgG2, bovine IgG2 and any other IgGs, proceed to elution step 7 only.

6. Elute the bound IgG with 0.5 ml elution buffer B1 directly into a fresh centrifuge tube containing 25 μ l neutralization buffer C to bring the pH of the sample to approximately 7.5. Centrifuge the Proteus spin column for 2 min at 1,800 g. Swirl the tube to ensure thorough mixing of the final eluate with neutralization buffer C. Repeat this elution step.

N.B: Do not pool the two eluate fractions if you want to recover **concentrated** purified antibody.

7. Elute the bound IgG with 0.5 ml elution buffer B2 directly into a fresh centrifuge tube containing 65 μ l neutralization buffer C to bring the pH of the sample to approximately 7.5. Centrifuge the Proteus spin column for 2 min at 1,800 g. Swirl the tube to ensure thorough mixing of the final eluate with neutralization buffer C. Repeat this elution step.

N.B: Do not pool the two eluate fractions if you want to recover **concentrated** purified antibody.

Pure Antibody

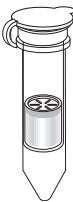
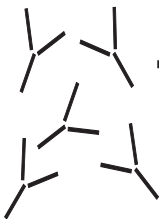

Used Spin Column

DESALTING AND CONCENTRATING THE PURIFIED ANTIBODY

8. If necessary, de-salt and concentrate the antibody preparation using the 10 kDa MWCO ultrafiltration spinner supplied. Add 0.05-0.2 % w/v sodium azide if the antibodies are to be stored at 2-8 °C. We recommend freezing the antibodies in small aliquots in 10-50 % glycerol at -20 °C for long term storage.

REGENERATION OF THE PROTEIN A MINI PLUG

9. Wash the Mini plugs twice with 0.65 ml elution buffer B2 (pH 2.5) by centrifuging the spin columns at 1,800 g for 2 min. Then wash the plugs twice with 0.65 ml binding buffer A (pH 9.0) by centrifuging the spin columns at 1,800 g for 2 min. Proceed to the pre-equilibration step of another bind-wash-elute cycle if the plugs are to be re-used immediately. After regeneration, plugs can also be stored, without their end caps, in binding buffer A or in 0.1 % sodium azide (made up in distilled water) at 2-8 °C until further use.

Easy-to-read Mini Purification Protocol E.g. Human serum

<i>Fraction</i>	<i>Volume</i>	<i>Step</i>	<i>RCF</i>	<i>Spin Time</i>
Pre-equilibration #1	0.65 ml	BBA pH 9.0	1,800 g	1 min
Pre-equilibration #2	0.65 ml	BBA pH 9.0	1,800 g	1 min
Sample Loading	0.65 ml	1:1 serum: BBA pH 9.0	640 g	6 min
Wash #1	0.65 ml	BBA pH 9.0	1,800 g	2 min
Wash #2	0.65 ml	BBA pH 9.0	1,800 g	2 min
Wash #3	0.65 ml	BBA pH 9.0	1,800 g	2 min
Final Eluate #1	0.5 ml	EB2 → 65 μ l NBC	1,800 g	2 min
Final Eluate #2	0.5 ml	EB2 → 65 μ l NBC	1,800 g	2 min

Easy-to-read Mini Regeneration Protocol

<i>Fraction</i>	<i>Volume</i>	<i>Step</i>	<i>RCF</i>	<i>Spin Time</i>
Clean-up #1	0.65 ml	EB2 pH 2.5	1,800 g	2 min
Clean-up #2	0.65 ml	EB2 pH 2.5	1,800 g	2 min
Wash #1	0.65 ml	BBA pH 9.0	1,800 g	2 min
Wash #2	0.65 ml	BBA pH 9.0	1,800 g	2 min

Table 3B. Midi spin columns:

Choice of Binding, Elution and Neutralization Buffers for the following antibody subclasses and host species.

Species	Subclass	Binding buffer	Elution buffer	Neutralization buffer (NB)
Mouse	IgG1	Buffer A	Buffer B1 →	Buffer C (add 0.5 ml NB to 10 ml final eluate) followed by
			→ Buffer B2 →	Buffer C (add 1.3 ml NB to 10 ml final eluate)
Mouse	IgG2a	Buffer A	Buffer B2 →	Buffer C (add 1.3 ml NB to 10 ml final eluate)
Mouse	IgG2b	Buffer A	Buffer B2 →	Buffer C (add 1.3 ml NB to 10 ml final eluate)
Mouse	IgG3	Buffer A	Buffer B2 →	Buffer C (add 1.3 ml NB to 10 ml final eluate)
Rat	IgG1	Buffer A	Buffer B1 →	Buffer C (add 0.5 ml NB to 10 ml final eluate) followed by
			→ Buffer B2 →	Buffer C (add 1.3 ml NB to 10 ml final eluate)
Rat	IgG2a	Buffer A	Buffer B1 →	Buffer C (add 0.5 ml NB to 10 ml final eluate) followed by
			→ Buffer B2 →	Buffer C (add 1.3 ml NB to 10 ml final eluate)
Rat	IgG2b	Buffer A	Buffer B1 →	Buffer C (add 0.5 ml NB to 10 ml final eluate) followed by
			→ Buffer B2 →	Buffer C (add 1.3 ml NB to 10 ml final eluate)
Rat	IgG2c	Buffer A	Buffer B2 →	Buffer C (add 1.3 ml NB to 10 ml final eluate)
Human	IgG1	Buffer A	Buffer B2 →	Buffer C (add 1.3 ml NB to 10 ml final eluate)
Human	IgG2	Buffer A	Buffer B2 →	Buffer C (add 1.3 ml NB to 10 ml final eluate)
Human	IgG3	Buffer A	Buffer B2 →	Buffer C (add 1.3 ml NB to 10 ml final eluate)
Human	IgG4	Buffer A	Buffer B2 →	Buffer C (add 1.3 ml NB to 10 ml final eluate)
Rabbit	IgG	Buffer A	Buffer B2 →	Buffer C (add 1.3 ml NB to 10 ml final eluate)
Guinea pig	IgG1	Buffer A	Buffer B2 →	Buffer C (add 1.3 ml NB to 10 ml final eluate)
Guinea pig	IgG2	Buffer A	Buffer B2 →	Buffer C (add 1.3 ml NB to 10 ml final eluate)

For all other Igs e.g. Hamster IgG, use elution buffer B2 only.

Step by step protocol for Midi Spin Columns

RESIN PLUG LOADING

1. Load the pre-packed resin Midi plug containing immobilized recombinant Protein A resin into the barrel of the Proteus spin column using the insertion tool as shown on page 15.

PRE-EQUILIBRATION (Total spin time = 3 mins)

2. Equilibrate the Protein A spin column with 10 ml binding buffer A, pH 9.0 by centrifuging the spin column at 500 g for 3 min*.

CLARIFICATION OF SAMPLE

3. Filter 12-15 ml sample through a single 1.2 μm (25 mm diameter) syringe filter to remove any cellular debris. Then, filter the partially clarified sample through a single 0.2 μm (25 mm diameter) syringe filter.

N.B: Protein precipitation is common during storage and repeated freeze/thaw cycles in ascites, sera and tissue culture supernatants. As with all forms of chromatography, it is important that the sample is filtered through a final 0.2 μm syringe filter **immediately** before loading it on to the spin column.

* If 1 spin column is to be used, ensure that the spin column is counterbalanced with a unit of equal weight (adjusted with distilled water) and without a Protein A resin plug.

SAMPLE LOADING (Total spin time = 30 mins)

4. Dilute the sample 1:1 (v/v; eg. add 10 ml 0.2 μm filtered sample to 10 ml binding buffer A, pH 9.0). Mix by inverting the capped tube 3-4 times. Pipette the 20 ml sample into the spin column. Centrifuge the spin column at 100 g for 30 min.

N.B: Increase the spin time or speed if any sample remains above the plug.

WASHING (Total spin time = 6 mins)

5. Wash the spin column twice with 10 ml binding buffer A, pH 9.0 to remove unbound contaminants by centrifuging the Proteus spin columns for 3 min at 500 g. The unbound wash will contain non-immunoglobulin components.

ELUTION (Total spin time = 6 mins)

For purifying mouse IgG1, rat IgG1, rat IgG2a, rat IgG2b and bovine IgG1, use both elution steps 6 and 7.

ELUTION (Total spin time = 6 mins)

For purifying unassigned IgG, mouse IgG2a, mouse IgG2b, mouse IgG3, rat IgG2c, human IgG1-IgG4, rabbit IgG, guinea pig IgG1, guinea pig IgG2, bovine IgG2 and any other IgGs, proceed to elution step 7 only.

6. Elute the bound IgG with 10 ml elution buffer B1 directly into a fresh centrifuge tube containing 0.5 ml neutralization buffer C to bring the pH of the sample to approximately 7.5. Centrifuge the Proteus spin column for 3 min at 500 g. Swirl the tube to ensure thorough mixing of the final eluate with neutralization buffer C. Repeat this elution step.

N.B: Do not pool the two eluate fractions if you want to recover **concentrated** purified antibody.

7. Elute the bound IgG with 10 ml elution buffer B2 directly into a fresh centrifuge tube containing 1.3 ml neutralization buffer C to bring the pH of the sample to approximately 7.5. Centrifuge the Proteus spin column for 3 min at 500 g. Swirl the tube to ensure thorough mixing of the final eluate with neutralization buffer C. Repeat this elution step.

N.B: Do not pool the two eluate fractions if you want to recover **concentrated** purified antibody.

Pure Antibody

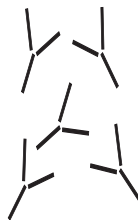

DESALTING AND CONCENTRATING THE PURIFIED ANTIBODY

8. If necessary, de-salt and concentrate the antibody preparation using the 10 kDa MWCO ultrafiltration spinner supplied. Add 0.05-0.2 % w/v sodium azide if the antibodies are to be stored at 2-8 °C. We recommend freezing the antibodies in small aliquots in 10-50 % glycerol at -20 °C for long term storage.

REGENERATION OF THE PROTEIN A MIDI PLUG

9. Wash the Midi plugs with 10 ml elution buffer B2 (pH 2.5) by centrifuging the spin columns at 500 g for 3 min. Then wash the plugs with 10 ml binding buffer A (pH 9.0) by centrifuging the spin columns at 500 g for 3 min. Proceed to the pre-equilibration step of another bind-wash-elute cycle if the plugs are to be re-used immediately. After regeneration, plugs can also be stored, without their end caps, in binding buffer A or in 0.1 % sodium azide (made up in distilled water) at 2-8 °C until further use.

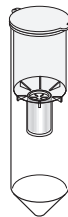

Used Spin Column

Easy-to-read Midi Purification Protocol E.g. Human serum

<i>Fraction</i>	<i>Volume</i>	<i>Step</i>	<i>RCF</i>	<i>Spin Time</i>
Pre-equilibration	10 ml	BBA pH 9.0	500 g	3 min
Sample Loading	20 ml	1:1 serum: BBA pH 9.0	100 g	30 min
Wash #1	10 ml	BBA pH 9.0	500 g	3 min
Wash #2	10 ml	BBA pH 9.0	500 g	3 min
Final Eluate #1	10 ml	EB2 → 1.3 ml NBC	500 g	3 min
Final Eluate #2	10 ml	EB2 → 1.3 ml NBC	500 g	3 min

Easy-to-read Midi Regeneration Protocol

<i>Fraction</i>	<i>Volume</i>	<i>Step</i>	<i>RCF</i>	<i>Spin Time</i>
Clean-up	10 ml	EB2 pH 2.5	500 g	3 min
Wash	10 ml	BBA pH 9.0	500 g	3 min



By using the Beer-Lambert law, $A = \epsilon \cdot c \cdot l$, the concentration of IgG (mg/ml) in the sample can be measured by multiplying the absorbance at 280 nm by 0.72. If IgM or IgA are purified, multiply the absorbance at 280 nm by 0.84 or 0.94, respectively. These antibody concentrations are only estimates as other contaminating proteins can also contribute to the absorbance reading. However, they can provide a reliable and quantitative method for determining the concentrations of pure antibody solutions. Most researchers use a sandwich ELISA assay to accurately measure antibody concentrations within a range of 1 mg/ml to 20 mg/ml sample.

The antibodies can also be monitored for purity by SDS-PAGE under reducing or non-reducing conditions. Note that IgG appears in a reducing SDS-PAGE as 25 kDa and 50-55 kDa bands (Fig. 3, page 35) and IgM appears as 25 kDa and 70-80 kDa bands. Recovery of immunoglobulins can be quantified by a standard protein assay, scanning densitometry of reducing or non-reducing SDS-polyacrylamide gels or ELISA. Antigen binding parameters can be measured for both affinity and avidity.

Fig. 3. Reducing SDS-Polyacrylamide gel of human IgG purified from serum with the Proteus Protein A kit

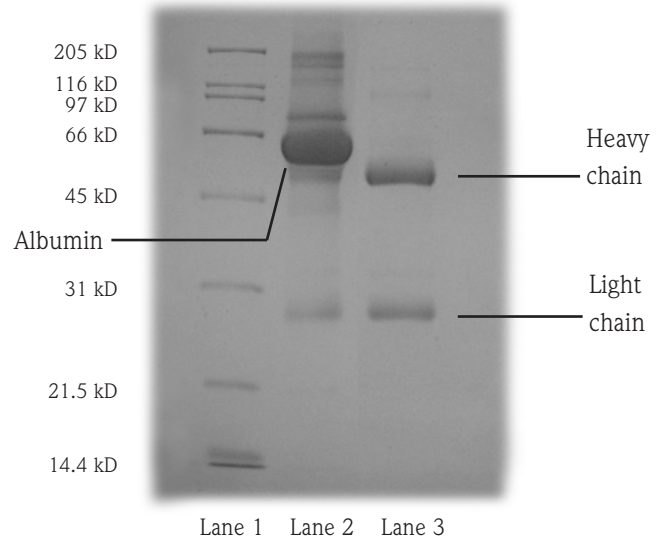

Lane 1: Molecular weight markers.

Lane 2: Human serum before loading on to the spin column.

Lane 3: Pure human IgG eluted from the Proteus Protein A spin column

Fig. 4a. Graph showing that typical IgG capacity of a Protein A **Mini** spin column remains unaffected after 3 re-uses using rabbit serum. All data is within 5 % of mean recovery (1.32 mg) and the % CV is 0.28 %.

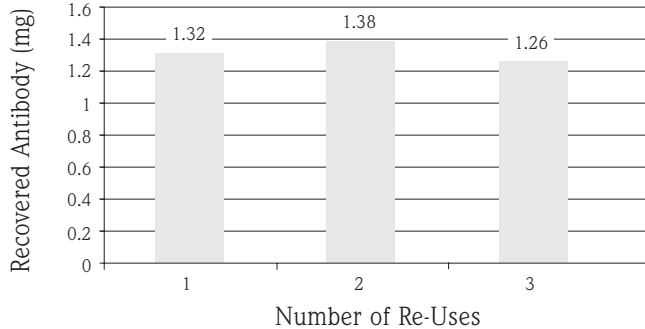
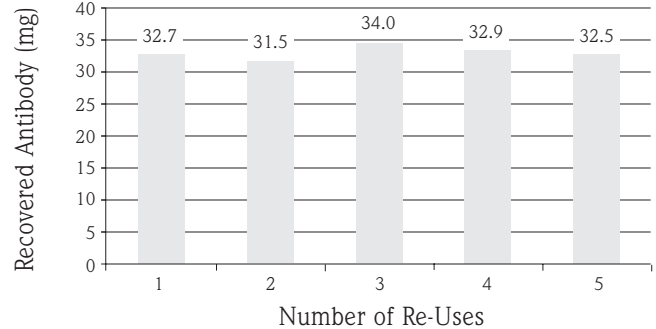

Fig. 4b. Graph showing that typical IgG capacity of a Protein A **Midi** spin column remains unaffected after 5 re-uses using rabbit serum. All data is within 5 % of mean recovery (32.7 mg) and the % CV is 2.5 %.



How to convert rpm to g force (RCF) using a swing bucket rotor

It is important that the Proteus spin columns are centrifuged at the correct speeds. Use of considerable higher speeds than those indicated may damage the resin matrix and result in reduced performance. Many centrifuges display only rpm. See the diagram to enable accurate conversion between rpm and RCF (g force). This formula will work on any rotor providing an accurate measurement is taken from the center of the rotor to the bottom of the swing bucket at its open position (when the bucket is rotated through 90° in its running position).

$$\text{RCF} = 1.12 \times r \left(\frac{\text{rpm}}{1000} \right)^2$$

Eg. 500 g corresponds to 1,670 rpm when the radius (r) = 160 mm.

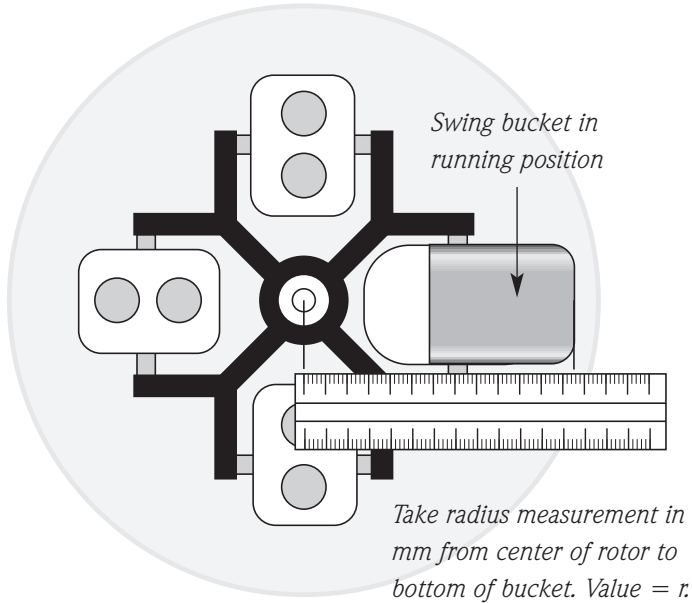

Take radius measurement in mm from center of rotor to center of microcentrifuge tube lid. Value = r_{min} .

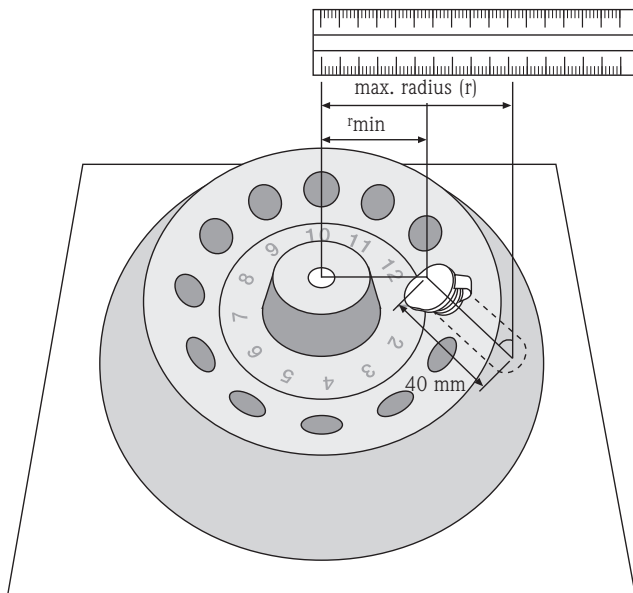

How to convert rpm to g force (RCF) using a 45° fixed angle rotor

It is important that the Proteus spin columns are centrifuged at the correct speeds. Use of considerable higher speeds than those indicated may damage the resin matrix and result in reduced performance. Many centrifuges display only rpm. See the diagram to enable accurate conversion between rpm and RCF (g force). This formula will work on any rotor providing an accurate measurement is taken from the center of the rotor to the centre of the microtube lid.

$$\text{RCF} = 1.12 \times r \left(\frac{\text{rpm}}{1000} \right)^2$$

Eg. 640 g corresponds to 3,000 rpm when the max radius (r) = 63.2 mm. (Eg. MSE Micro Centaur microfuge).
1770 g corresponds to 5,000 rpm when the max radius (r) = 63.2 mm. (Eg. MSE Micro Centaur microfuge).

Determination of the maximum radius (r)

$r = \text{minimum radius in mm (} r_{min} \text{)} + 40 \text{ mm (the length of the micro-centrifuge tube). } \sin 45^\circ$

Protein A kit buffer formulation:

Use the following recipes to prepare the buffers supplied with the Proteus Protein A kit. All buffers contain 0.1 % sodium azide as a preservative and can be stored at room temperature:

Binding Buffer A (1.5 M Glycine/NaOH buffer, 3 M NaCl, pH 9.0)

Add 112.6 g glycine (free base; M_r 75.07), 175.3 g NaCl (M_r 58.44), 1.0 g NaN_3 to 800 ml distilled water. Titrate with 5 M NaOH to pH 9.0. Make up final volume to 1 l with distilled water.

Elution Buffer B1 (0.1 M Sodium citrate buffer pH 5.5)

Add 23.44 g citric acid (trisodium salt, dihydrate; M_r 294.1), 3.872 g citric acid (anhydrous; M_r 192.1), 1.0 g NaN_3 to 900 ml distilled water. Make up final volume to 1 l with distilled water.

Elution Buffer B2 (0.2 M Glycine/HCl buffer pH 2.5)

Add 15.0 g glycine (free base; M_r 75.07), 1.0 g NaN_3 to 900 ml distilled water. Titrate with 5 M HCl to pH 2.5. Make up final volume to 1 l with distilled water.

Neutralization Buffer C (1 M Tris/HCl buffer pH 9.0)

Add 103.72 g Tris base (M_r 121.1), 22.72 g Tris hydrochloride (M_r 157.6), 1.0 g NaN_3 to 800 ml distilled water. Make up final volume to 1 l with distilled water.

Questions and Answers:

1. What is the preferred rotor for the Proteus Mini and Midi spin columns?

Mini spin columns: The preferred rotor is a fixed angle rotor. There is no need to orientate the Mini spin column in the fixed angle rotor.

Midi spin columns: The preferred rotor is a swing bucket rotors. For optimal performance with a fixed angle rotor, ensure that the orientation of the spin column in the rotor is the same for sample binding, washing and elution steps

2. Do I need to filter the buffers prepared in my laboratory?

It is good laboratory practice to filter all buffers. However, buffers supplied with the kit are pre-filtered for immediate use.

3. Do I need to pre-filter my sample before loading it on to a Proteus spin column?

All samples must be filtered through a 0.2 μm pre-filter **immediately** before loading the samples on to the spin column.

4. What are the typical binding capacities of Proteus Mini and Midi spin columns?

Mini spin columns: Protein A and G resin plugs have typical capacities of 1 mg rabbit IgG from serum.

Midi spin columns: Protein A and G resin plugs have minimum capacities of 20 mg rabbit IgG from serum.

5. How should I prepare my sample for the Proteus spin column?

Many chromatographic procedures demand that the sample is pre-conditioned prior to loading. Protein A affinity separations usually require the sample to be diluted 1:1 (v/v) in 1 x binding buffer. We recommend that all samples are diluted 1:1 (v/v) in the binding buffer supplied with the Protein A or Protein G kit.

6. How can I process a large volume sample?

The Mini and Midi spin columns have a finite maximum volume capacity. If you have a volume of sample (>200 ml), we recommend that you use either use the ProVac Protein A and G vacuum column kits (see page 50 for the relevant order codes) or the established procedure of ammonium sulphate precipitation to concentrate your target antibody. Although many IgGs (γ -globulins) precipitate at a lower concentration of ammonium sulphate than most other proteins, 50% ammonium sulphate is sufficient. Please visit the Pro-Chem website for the ammonium sulphate protocol.

7. What is the maximum volume of solution I can load on to a Mini or Midi spin column?

Mini spin columns: You can load a maximum volume of 0.65 ml.

Midi spin columns: You can load up to 20 ml in a swing bucket rotor and up to 10 ml in a fixed angle rotor.

8. What is the highest speed that I can spin the Proteus Mini and Midi spin columns?

Mini spin columns: Although the spin columns have been tested at 11,960 g (13,000 rpm in a fixed angle rotor with an average radius of 49 mm), we do not recommend spin speeds greater than 5,000 g. At very high speed, you may observe gel shrinkage away from the side walls. This will not affect the performance of the spin columns as the gel will rehydrate rapidly in subsequent spin steps.

Midi spin columns: There is no need to spin the devices at speeds greater than 1,250 g. No performance data is available at centrifugal speeds greater than 1,500 g.

9. Is there a minimum spin speed for the Mini and Midi spin columns?

There is no minimum spin speed for either the Mini or Midi spin columns. The devices can be spun at speeds as low as 50 g.

10. *What are the minimum elution volumes from the Proteus spin columns?*

Mini spin columns: The minimum elution volume is 0.5 ml.

Midi spin columns: The minimum elution volume is 5 ml.

11. *How many times can I re-use the Proteus Mini and Midi spin columns?*

Mini spin columns: Assuming that all samples are correctly filtered, sufficient buffer is provided in the kit for 3 re-uses of each Mini spin column.

Midi spin columns: Each Midi plug can be re-used typically up to 5 times. There is sufficient buffer volume in the kit for one complete use of each Midi spin column.

12. *How can I regenerate the Proteus Protein A plug?*

Mini spin columns: We recommend that you wash the plugs with 2 x 0.65 ml elution buffer B2 (pH 2.5) by centrifuging the spin columns at 1,800 g for 2 min. Then, re-equilibrate the plugs with 2 x 0.65 ml binding buffer A by centrifuging the spin columns at 1,800 g for 2 min. Proceed to the pre-

equilibration step if plugs are to be re-used immediately. Do note that spin times of used plugs may be longer. After regeneration, plugs can also be stored, without their end caps, in a beaker containing 0.1 % sodium azide (made up in distilled water) at 2-8 °C until further use.

Midi spin columns: We recommend that you wash the plugs with 10 ml elution buffer B2 (pH 2.5) by centrifuging the spin columns at 500 g for 3 min. Then, re-equilibrate the plugs with 10 ml binding buffer A by centrifuging the spin columns at 500 g for 3 min. Proceed to the pre-equilibration step if plugs are to be re-used immediately. Do note that spin times of used plugs may be longer. After regeneration, plugs can also be stored, without their end caps, in a beaker containing 0.1 % sodium azide (made up in distilled water) at 2-8 °C until further use.



13. Do I need to perform regeneration of the spin column immediately after the elution step?

We do not recommend storing the resin columns in elution buffer pH 2.5. Prolonged storage in pH 2.5 buffer could harm the Protein A ligand. After the elution step, continue to the regeneration procedure. The resin plugs can then be stored for re-use.

14. Can I autoclave the Proteus Protein A and Protein G plugs?

The Proteus Protein A or G plugs cannot be autoclaved.

15. If I experience significant fouling of the resin plug, do you recommend any cleaning-in-place procedures?

Most suitable cleaning procedures tend to be determined empirically. The chosen procedure depends largely upon the nature of the previous sample loaded on the spin column. Consult Pro-Chem's website for some CiP procedures.

16. What shall I do if the binding buffer A is translucent yellow?

This is a property of the Glycine component of binding buffer A. There is no adverse affect on the performance of the plug or the integrity of your antibody. Continue to use this binding buffer bottle for your purification.

17. Should I be concerned if the plugs partially dry out during the centrifugal steps?

The plugs are robust. Partially dried plugs rehydrate rapidly. There are no adverse effect upon the performance of the plugs.

18. Do I need to be careful with the type of chaotropic ion I use when eluting antibodies from affinity columns?

It is recommended to use the mildest chaotropic agents at the lowest possible concentration that will ensure rapid elution and high recovery of activity. Iodination reactions employing either chloramine T or IODO-GEN (1,3,4,6-tetrachloro-3-6-diphenylglycouril) are particularly sensitive to inhibition by low concentrations of thiocyanate ions and, if antibodies are eluted from affinity columns or Protein A affinity columns, using this chaotropic ion, it is essential that they are dialyzed thoroughly after elution to remove thiocyanate ions.

19. How do I monitor purity of the isolated antibodies?

Purity is best measured by gel electrophoresis. When analyzed by SDS-PAGE under non-reducing conditions, IgG antibodies should give a single protein band of about 160-170 kDa. On reduction with DTT or 2-mercaptoethanol, two or more bands will be seen corresponding to the individual heavy chains (50-55 kDa) or light chains (25-30 kDa).

Other protein bands that are visible only on reduction may point to proteolytic action. This can often be prevented by careful use of protease inhibitors in culture supernatants before storage.

20. What are the critical starting conditions for Protein A and G Proteus spin columns?

Sample pH and salt concentration are usually not critical, except that the pH should be equal to or above 5.0. Protein A or G spin columns can also serve as tools for rapid buffer exchange. However, the salt concentration is normally quite high (> 0.1 M) to prevent non-specific binding.

21. Do I need to control the salt concentrations during Protein A and G chromatography?

Use 0.1-0.5 M salt to reduce non-specific adsorption. When working with Protein A, use high salt (2-3 M NaCl) with high pH to promote the binding of mouse IgG1.

22. Is pH an important parameter to control during Protein A and G chromatography?

The elution pH is the most critical variable. Protein G usually requires more acidic pH conditions to desorb the target immunoglobulins. For Protein A, elution by pH steps (starting at pH 6) may fractionate different species (weaker binding bovine IgG from target antibodies) or subclasses. High pH (pH 8-9), in conjunction with high salt may promote binding of mouse IgG1 to Protein A. The binding buffer pH should normally be higher than pH 6.0-7.0.

23. Can I elute antibodies from a Protein A and G spin column using divalent cations?

Concentrations of divalent cations (particularly Mg^{2+}) up to 1 M can sometimes replace acidic pH if there is concern about loss of activity of acid-labile immunoglobulins.

Troubleshooting assistant:*Bubbles or cracks appear in the resin bed*

- The spin column has been stored at a cool temperature and then rapidly warmed up. Proteus spin columns should be warmed slowly to room temperature before use.

The sample does not flow easily through the spin column

- The resin is clogged with particulates. Pre-filter the sample just before loading it on to the Proteus spin column. Ascites must be delipidated before use. Please refer to page 26 for the recommended delipidation procedure.
- If the spin columns are not stored at 2-8 °C, or they have been used more than once and stored in the absence of a bacteriostat, microbial growth in the column may restrict flow through the resin plug.
- The spin times for the sample loading step should be increased to a maximum of 1,500 g.

No elution of the target protein is observed from the spin column

- The pH of the elution buffer may be incorrect. It is advisable to prepare new solutions.
- The elution conditions are too mild to desorb the target protein.

The recovery of target protein is low

- The binding of antibodies to Protein A or G is attributed in part to hydrophobic forces. Use chaotropic salts to reduce the strength of all hydrophobic interactions.

Poor resolution of the target protein

- The sample volume or concentration may be too large for the capacity of the resin plug. In this case, reduce the sample load or sample volume.
- The sample may also need to be filtered carefully.



The target protein elutes at an unexpected position

- There may be an ionic interaction between the protein and Proteus resin. You should maintain the ionic strength above 50 mM.
- There may be hydrophobic interactions between the sample and Proteus resin. In this instance, reduce the salt concentration and add suitable detergents or organic solvents.
- The column may be dirty. All claims made of Proteus spin columns are guaranteed for the first bind-wash-elute cycle only.

The elution profile cannot be reproduced

- The nature of the sample may have altered and so it may be important to prepare a fresh sample.
- The sample load may be different from the original sample load. It is advisable to keep all these parameters constant.
- Proteins or lipids may have precipitated in the resin bed. Use elution conditions which stabilize the sample.
- The buffer pH and ionic strength is incorrect and new buffers will need to be prepared.

Glossary:

affinity chromatography - chromatographic separation based on a specific interaction between an immobilized ligand and a binding site on a macromolecule.

antibody - an immunoglobulin produced by the immune system of vertebrates in response to exposure to a foreign substance.

antigen - a molecule which can bind specifically to an antibody.

antiserum - the serum fraction from an animal that has been immunized or exposed to an immunogen and contains antibodies to a particular antigen.

ascites - a liquid tumour formed by injection of a hybridoma cell line into the peritoneal cavity. It is a common source of monoclonal antibodies from mice.

bed volume - the total volume occupied by the chromatographic packed bed. It is also referred to as the column volume or CV.

cell culture supernatant - the fluid made during cell culture (either roller bottle, suspension or perfusion) containing tissue media components and the secreted target.

chaotropic agent - a molecule which interferes with hydrophobic interactions by disrupting the ordered structure of water molecules. Examples include urea and guanidine.

hybridoma - a hybrid cell line produced by fusing antibody producing cells with myeloma cells to generate immortal reproducing cells that produce specific monoclonal antibodies indefinitely in cell culture.

immobilized - bound to a surface, usually through covalent linkages.

immunoglobulin (Ig) - comprising 5 distinct classes in most higher animals. Classes called IgG (the most common), IgM, IgA, IgD and IgE. They differ from each other in size, charge, amino acid composition and carbohydrate content.

ion exchange chromatography - chromatographic separation based on different charge properties of macromolecules.

isoelectric point - the pH at which the protein has no net charge.

monoclonal antibody - an antibody derived from a single clone of immune cells. They are usually formed from a hybridoma cell line.

polyclonal antibodies - antibodies produced to the same immunogen by different cell types. Antibodies from antiserum are almost always polyclonal.

protein A/protein G - cell wall proteins of certain pathogenic bacteria which specifically bind to the Fc region of immunoglobulins.



References:**Affinity Separations: A Practical Approach**

1997 (Matejtschuk, P Ed.) IRL PRESS at Oxford University Press. ISBN: 0-19-963550-1.

Biochemistry, 2nd Edition

1996 (Mathews, CK & van Holde, KE) Benjamin/Cummings Publ. Co. ISBN: 0-8053-3931-0.

Purification Tools for Monoclonal Antibodies

1996 (P Gagnon) Validated Biosystems, USA, ISBN: 0-9653515-9-9.

Biochemistry, 4th Edition

1995 (L Stryer) WH Freeman and Co. ISBN: 0-7167-2009-4.

Immunology

1985 (I Roitt, J Brostoff, D Male) Gower Medical Publ. Ltd., ISBN: 0-443-02912-1.

Protein Purification Applications: A Practical Approach

1995 (E.L.V. Harris and S. Angal Eds.) IRL PRESS at Oxford University Press. ISBN: 0-19-963023-2.

Basic Proteins and Peptide Protocols

1994 (J Walker Ed.) Humana Press, ISBN: 0-89603-269-8.

Recombinant Protein Protocols

1997 (RS Tuan Ed.) Humana Press, ISBN: 0-89603-400-3.

Ordering Information:

Spin Column Kits	Quantity	Order codes
Mini Protein A Sample Kit (2 A Spin Columns)	1	PC-MA02
Mini Protein G Sample Kit (2 G Spin Columns)	1	PC-MG02
Mini Protein A & G Starter Pack (2 A & 2 G Spin Columns)	1	PC-MAG04
Mini Protein A Kit (16 units)	1	PC-MAK16
Mini Protein G Kit (16 units)	1	PC-MGK16
Mini Protein A Bulk Pack (48 units)	1	PC-MAC48
Mini Protein G Bulk Pack (48 units)	1	PC-MGC48
Midi Protein A Kit (4 units)	1	PC-AK04
Midi Protein G Kit (4 units)	1	PC-GK04
Midi Protein A Bulk Pack (12 units)	1	PC-AC12
Midi Protein G Bulk Pack (12 units)	1	PC-GC12

Vacuum Column Kits	Quantity	Order codes
Protein A Midi Vacuum Kit with Vacuum head (4 units)	1	V-AK04SP
Protein G Midi Vacuum Kit with Vacuum head (4 units)	1	V-GK04SP
Protein A Midi Vacuum Pack (4 units)	1	V-AK04
Protein G Midi Vacuum Pack (4 units)	1	V-GK04
Protein A Midi Vacuum Bulk Pack (12 units)	1	V-AC12
Protein G Midi Vacuum Bulk Pack (12 units)	1	V-GC12

Accessories	Quantity	Order codes
Protein A Buffer Pack	1	PC-BAP
Protein G Buffer Pack	1	PC-BGP
ProVac Vacuum Head (1 Unit)	1	V-PVAC
Vacuum Accessory Pack	1	V-ACPK





Pro-Chem Inc, 521 Great Road, Littleton, MA 01460, USA.

Tel: 866 635 3738 (toll free Canada and USA)

Tel: 978 952 6285 Fax: 978 952 6143

E-mail: info@protein-chem.com Web: www.protein-chem.com

© 2005 Pro-Chem Inc.